

Catalogue avec tarifs Meules pour machines manuelles toutes marques

Choix + Qualité



COMARTEX

☎ 01 45 76 53 03

☎ 01 45 76 76 82

mail : comartex@comartex.fr

site : www.comartex.com



De la qualité, des prix et du choix...

La preuve en vidéo sur le

www.COMARTEX.com

PROFILI STANDARD STANDARD PROFILES

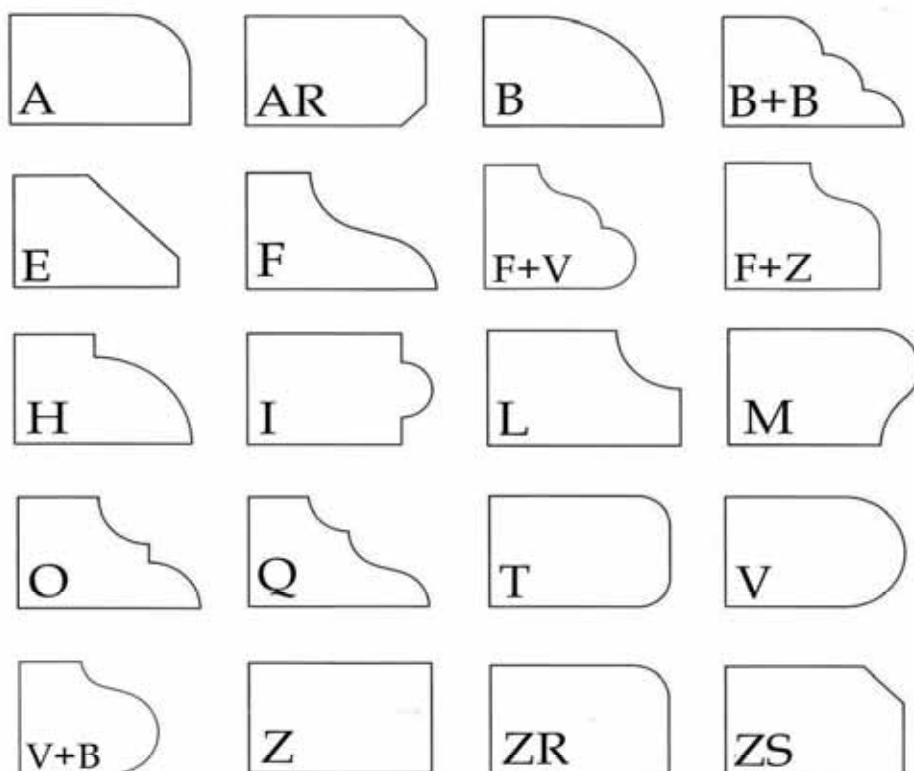

COMARTEX

☎ 01 45 76 53 03

☎ 01 45 76 76 82

mail : comartex@comartex.fr

site : www.comartex.com



De la qualité, des prix et du choix...

La preuve en vidéo sur le

www.COMARTEX.com

MOLA PROFILO **A20** MACCHINE MANUALI COMPLETA DI TASTATORE E VITE M8

*PROFILE **A20** WHEEL FOR HAND HELD MACHINE WITH TRACER AND SCREW M8*



R=10

Codice ADI <i>ADI Code</i>	Descrizione <i>Description</i>	Posizione <i>Position</i>	Codice Tastatore <i>Tracer Code</i>	Codice Vite <i>Screw Code</i>	Prezzo <i>Price</i> [€URO]
PM53001	Mola Pr. A D.66 S=20	00	PM14809	PM14902	281
PM54001	Mola Pr. A D.66 S=20	2	PM14805	PM14902	281
PM35075	Mola Pr. A Rubber D.66 S=20	3	-	-	100
PM35076	Mola Pr. A Rubber D.66 S=20	4	-	-	100
PM35077	Mola Pr. A Rubber D.66 S=20	5	-	-	100
PM35078	Mola Pr. A Rubber D.66 S=20	6	-	-	100
COSTO SET COMPLETO - <i>COMPLETE SET PRICE</i>					962

PM57001	Mola Pr. A D.66 S=20	00	PM14805	PM14902	281
Mola per profilatura unica in macchina (finitura manuale) <i>One Step Profiling Wheel (Finishing by Hand)</i>					

COMARTEX

☎ 01 45 76 53 03

☎ 01 45 76 76 82

mail : comartex@comartex.fr

site : www.comartex.com



De la qualité, des prix et du choix...

La preuve en vidéo sur le

www.COMARTEX.com

MOLA PROFILO **A30** MACCHINE MANUALI COMPLETA DI TASTATORE E VITE M8

*PROFILE **A30** WHEEL FOR HAND HELD MACHINE WITH TRACER AND SCREW M8*

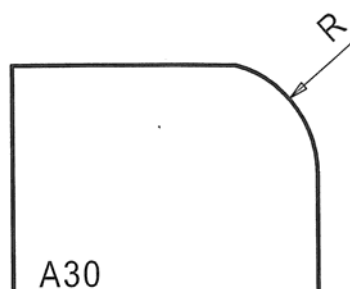

R=15

Codice ADI <i>ADI Code</i>	Descrizione <i>Description</i>	Posizione <i>Position</i>	Codice Tastatore <i>Tracer Code</i>	Codice Vite <i>Screw Code</i>	Prezzo <i>Price</i> [€URO]
PM53002	Mola Pr. A D.76 S=30	00	PM14809	PM14904	329
PM54002	Mola Pr. A D.76 S=30	2	PM14805	PM14904	329
PM35001	Mola Pr. A Rubber D.98 S=30	3	-	-	110
PM35002	Mola Pr. A Rubber D.98 S=30	4	-	-	110
PM35003	Mola Pr. A Rubber D.98 S=30	5	-	-	110
PM35004	Mola Pr. A Rubber D.98 S=30	6	-	-	110
COSTO SET COMPLETO - <i>COMPLETE SET PRICE</i>					1098

PM57002	Mola Pr. A D.76 S=30	00	PM14805	PM14904	329
Mola per profilatura unica in macchina (finitura manuale)					
<i>One Step Profiling Wheel (Finishing by Hand)</i>					

COMARTEX

☎ 01 45 76 53 03

☎ 01 45 76 76 82

mail : comartex@comartex.fr

site : www.comartex.com



De la qualité, des prix et du choix...

La preuve en vidéo sur le

www.COMARTEX.com

MOLA PROFILO **A40** MACCHINE MANUALI COMPLETA DI TASTATORE E VITE M8

*PROFILE **A40** WHEEL FOR HAND HELD MACHINE WITH TRACER AND SCREW M8*

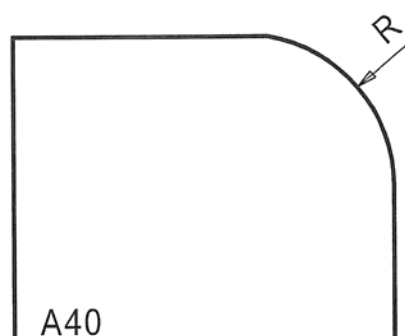

R=20

Codice ADI <i>ADI Code</i>	Descrizione <i>Description</i>	Posizione <i>Position</i>	Codice Tastatore <i>Tracer Code</i>	Codice Vite <i>Screw Code</i>	Prezzo <i>Price</i> [€URO]
PM53003	Mola Pr. A D.87 S=40	00	PM14809	PM14906	409
PM54003	Mola Pr. A D.87 S=40	2	PM14805	PM14906	409
PM35042	Mola Pr. A Rubber D.113 S=40	3	-	-	136
PM35043	Mola Pr. A Rubber D.113 S=40	4	-	-	136
PM35044	Mola Pr. A Rubber D.113 S=40	5	-	-	136
PM35045	Mola Pr. A Rubber D.113 S=40	6	-	-	136
COSTO SET COMPLETO - <i>COMPLETE SET PRICE</i>					1362

PM57003	Mola Pr. A D.87 S=40	00	PM14805	PM14906	409
Mola per profilatura unica in macchina (finitura manuale)					
<i>One Step Profiling Wheel (Finishing by Hand)</i>					

COMARTEX

☎ 01 45 76 53 03

☎ 01 45 76 76 82

mail : comartex@comartex.fr

site : www.comartex.com



De la qualité, des prix et du choix...

La preuve en vidéo sur le

www.COMARTEX.com

MOLA PROFILO **AR20** MACCHINE MANUALI COMPLETA DI TASTATORE E VITE M8

*PROFILE **AR20** WHEEL FOR HAND HELD MACHINE WITH TRACER AND SCREW M8*

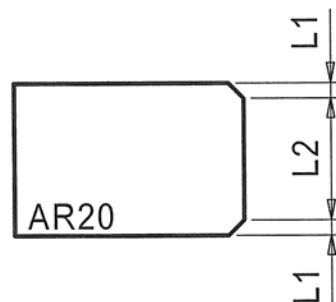

L1=2 L2=16

Codice ADI <i>ADI Code</i>	Descrizione <i>Description</i>	Posizione <i>Position</i>	Codice Tastatore <i>Tracer Code</i>	Codice Vite <i>Screw Code</i>	Prezzo <i>Price</i> [€URO]
PM53102	Mola Pr. AR D.48 S=20	00	PM14804	PM14902	405
PM54102	Mola Pr. AR D.48 S=20	2	PM14801	PM14902	405
PM35208	Mola Pr. AR Rubber D.78 S=20	3	-	-	111
PM35209	Mola Pr. AR Rubber D.78 S=20	4	-	-	111
PM35210	Mola Pr. AR Rubber D.78 S=20	5	-	-	111
PM35211	Mola Pr. AR Rubber D.78 S=20	6	-	-	111
COSTO SET COMPLETO - <i>COMPLETE SET PRICE</i>					1254

PM57102	Mola Pr. AR D.48 S=20	00	PM14801	PM14902	405
Mola per profilatura unica in macchina (finitura manuale) <i>One Step Profiling Wheel (Finishing by Hand)</i>					

COMARTEX

☎ 01 45 76 53 03

☎ 01 45 76 76 82

mail : comartex@comartex.fr

site : www.comartex.com



De la qualité, des prix et du choix...

La preuve en vidéo sur le

www.COMARTEX.com

MOLA PROFILO **AR30** MACCHINE MANUALI COMPLETA DI TASTATORE E VITE M8

*PROFILE **AR30** WHEEL FOR HAND HELD MACHINE WITH TRACER AND SCREW M8*

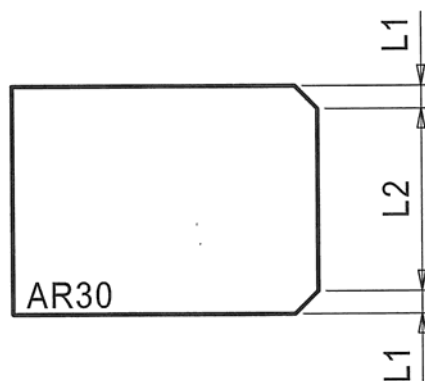

L1=3 L2=24

Codice ADI <i>ADI Code</i>	Descrizione <i>Description</i>	Posizione <i>Position</i>	Codice Tastatore <i>Tracer Code</i>	Codice Vite <i>Screw Code</i>	Prezzo <i>Price</i> [€URO]
PM53103	Mola Pr. AR D.50 S=30	00	PM14804	PM14902	465
PM54103	Mola Pr. AR D.50 S=30	2	PM14801	PM14902	465
PM35046	Mola Pr. AR Rubber D.90 S=30	3	-	-	129
PM35047	Mola Pr. AR Rubber D.90 S=30	4	-	-	129
PM35048	Mola Pr. AR Rubber D.90 S=30	5	-	-	129
PM35049	Mola Pr. AR Rubber D.90 S=30	6	-	-	129
COSTO SET COMPLETO - <i>COMPLETE SET PRICE</i>					1446

PM57103	Mola Pr. AR D.50 S=30	00	PM14801	PM14902	465
Mola per profilatura unica in macchina (finitura manuale) <i>One Step Profiling Wheel (Finishing by Hand)</i>					

COMARTEX

☎ 01 45 76 53 03

☎ 01 45 76 76 82

mail : comartex@comartex.fr

site : www.comartex.com



De la qualité, des prix et du choix...

La preuve en vidéo sur le

www.COMARTEX.com

MOLA PROFILO **AR40** MACCHINE MANUALI COMPLETA DI TASTATORE E VITE M8

PROFILE **AR40** WHEEL FOR HAND HELD MACHINE WITH TRACER AND SCREW M8

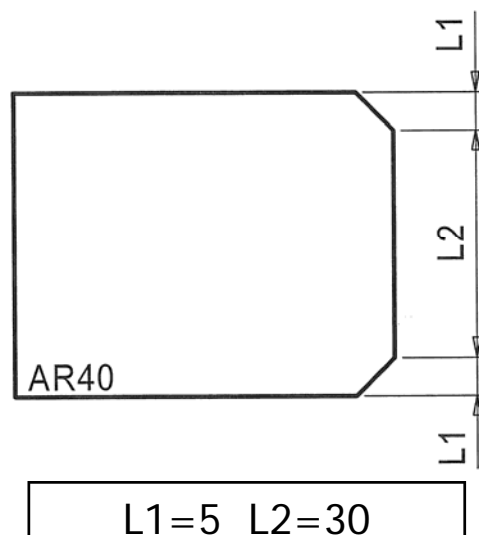

Codice ADI <i>ADI Code</i>	Descrizione <i>Description</i>	Posizione <i>Position</i>	Codice Tastatore <i>Tracer Code</i>	Codice Vite <i>Screw Code</i>	Prezzo <i>Price</i> [€URO]
PM53104	Mola Pr. AR D.55 S=40	00	PM14804	PM14904	602
PM54104	Mola Pr. AR D.55 S=40	2	PM14801	PM14904	602
PM35212	Mola Pr. AR Rubber D.100 S=40	3	-	-	146
PM35213	Mola Pr. AR Rubber D.100 S=40	4	-	-	146
PM35214	Mola Pr. AR Rubber D.100 S=40	5	-	-	146
PM35215	Mola Pr. AR Rubber D.100 S=40	6	-	-	146
COSTO SET COMPLETO - <i>COMPLETE SET PRICE</i>					1788

PM57104	Mola Pr. AR D.55 S=40	00	PM14801	PM14904	602
Mola per profilatura unica in macchina (finitura manuale)					
<i>One Step Profiling Wheel (Finishing by Hand)</i>					

COMARTEX

☎ 01 45 76 53 03

☎ 01 45 76 76 82

mail : comartex@comartex.fr

site : www.comartex.com



De la qualité, des prix et du choix...

La preuve en vidéo sur le

www.COMARTEX.com

MOLA PROFILO **B20** MACCHINE MANUALI COMPLETA DI TASTATORE E VITE M8

*PROFILE **B20** WHEEL FOR HAND HELD MACHINE WITH TRACER AND SCREW M8*

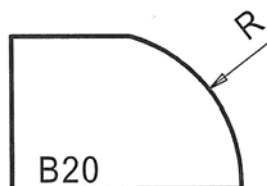

R=20

Codice ADI <i>ADI Code</i>	Descrizione <i>Description</i>	Posizione <i>Position</i>	Codice Tastatore <i>Tracer Code</i>	Codice Vite <i>Screw Code</i>	Prezzo <i>Price</i> [€URO]
PM53004	Mola Pr. B D.86 S=20	00	PM14809	PM14902	341
PM54004	Mola Pr. B D.86 S=20	2	PM14805	PM14902	341
PM35092	Mola Pr. B Rubber D.115 S=20	3	-	-	110
PM35093	Mola Pr. B Rubber D.115 S=20	4	-	-	110
PM35094	Mola Pr. B Rubber D.115 S=20	5	-	-	110
PM35095	Mola Pr. B Rubber D.115 S=20	6	-	-	110
COSTO SET COMPLETO - <i>COMPLETE SET PRICE</i>					1122

PM57004	Mola Pr. B D.86 S=20	00	PM14805	PM14902	341
Mola per profilatura unica in macchina (finitura manuale) <i>One Step Profiling Wheel (Finishing by Hand)</i>					

COMARTEX

☎ 01 45 76 53 03

☎ 01 45 76 76 82

mail : comartex@comartex.fr

site : www.comartex.com



De la qualité, des prix et du choix...

La preuve en vidéo sur le

www.COMARTEX.com

MOLA PROFILO **B30** MACCHINE MANUALI COMPLETA DI TASTATORE E VITE M8

*PROFILE **B30** WHEEL FOR HAND HELD MACHINE WITH TRACER AND SCREW M8*



R=30

Codice ADI <i>ADI Code</i>	Descrizione <i>Description</i>	Posizione <i>Position</i>	Codice Tastatore <i>Tracer Code</i>	Codice Vite <i>Screw Code</i>	Prezzo <i>Price</i> [€URO]
PM53005	Mola Pr. B D.104 S=30	00	PM14809	PM14904	405
PM54005	Mola Pr. B D.104 S=30	2	PM14805	PM14904	405
PM35113	Mola Pr. B Rubber D.130 S=30	3	-	-	119
PM35114	Mola Pr. B Rubber D.130 S=30	4	-	-	119
PM35115	Mola Pr. B Rubber D.130 S=30	5	-	-	119
PM35116	Mola Pr. B Rubber D.130 S=30	6	-	-	119
COSTO SET COMPLETO - <i>COMPLETE SET PRICE</i>					1286

PM57005	Mola Pr. B D.104 S=30	00	PM14805	PM14904	405
Mola per profilatura unica in macchina (finitura manuale) <i>One Step Profiling Wheel (Finishing by Hand)</i>					

COMARTEX

☎ 01 45 76 53 03

☎ 01 45 76 76 82

mail : comartex@comartex.fr

site : www.comartex.com



De la qualité, des prix et du choix...

La preuve en vidéo sur le

www.COMARTEX.com

MOLA PROFILO **B40** MACCHINE MANUALI COMPLETA DI TASTATORE E VITE M8

*PROFILE **B40** WHEEL FOR HAND HELD MACHINE WITH TRACER AND SCREW M8*

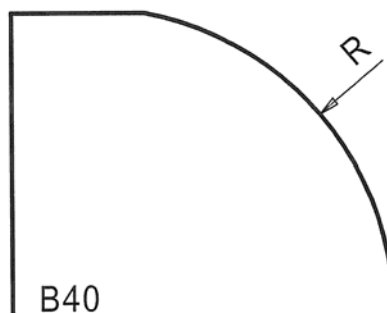

R=40

Codice ADI <i>ADI Code</i>	Descrizione <i>Description</i>	Posizione <i>Position</i>	Codice Tastatore <i>Tracer Code</i>	Codice Vite <i>Screw Code</i>	Prezzo <i>Price</i> [€URO]
PM53006	Mola Pr. B D.124 S=40	00	PM14809	PM14906	564
PM54006	Mola Pr. B D.124 S=40	2	PM14805	PM14906	564
PM35022	Mola Pr. B Rubber D.140 S=40	3	-	-	142
PM35023	Mola Pr. B Rubber D.140 S=40	4	-	-	142
PM35024	Mola Pr. B Rubber D.140 S=40	5	-	-	142
PM35025	Mola Pr. B Rubber D.140 S=40	6	-	-	142
COSTO SET COMPLETO - <i>COMPLETE SET PRICE</i>					1696

PM57006	Mola Pr. B D.124 S=40	00	PM14805	PM14906	564
Mola per profilatura unica in macchina (finitura manuale) <i>One Step Profiling Wheel (Finishing by Hand)</i>					

COMARTEX

☎ 01 45 76 53 03

☎ 01 45 76 76 82

mail : comartex@comartex.fr

site : www.comartex.com



De la qualité, des prix et du choix...

La preuve en vidéo sur le

www.COMARTEX.com

MOLA PROFILO **B+B20** MACCHINE MANUALI COMPLETA DI TASTATORE E VITE M8

*PROFILE **B+B20** WHEEL FOR HAND HELD MACHINE WITH TRACER AND SCREW M8*

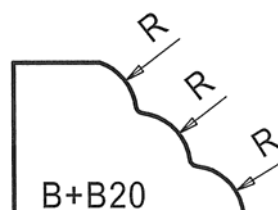

$$R = 7$$

Codice ADI <i>ADI Code</i>	Descrizione <i>Description</i>	Posizione <i>Position</i>	Codice Tastatore <i>Tracer Code</i>	Codice Vite <i>Screw Code</i>	Prezzo <i>Price</i> [€URO]
PM53026	Mola Pr. B+B D.84 S=20	00	PM14809	PM14903	503
PM54026	Mola Pr. B+B D.84 S=20	2	PM14805	PM14903	503
PM35096	Mola Pr. B+B Rubber D.110 S=20	3	-	-	125
PM35097	Mola Pr. B+B Rubber D.110 S=20	4	-	-	125
PM35098	Mola Pr. B+B Rubber D.110 S=20	5	-	-	125
PM35099	Mola Pr. B+B Rubber D.110 S=20	6	-	-	125
COSTO SET COMPLETO - <i>COMPLETE SET PRICE</i>					1506

PM57026	Mola Pr. B+B D.84 S=20	00	PM14805	PM14903	503
Mola per profilatura unica in macchina (finitura manuale) <i>One Step Profiling Wheel (Finishing by Hand)</i>					

COMARTEX

☎ 01 45 76 53 03

☎ 01 45 76 76 82

mail : comartex@comartex.fr

site : www.comartex.com



De la qualité, des prix et du choix...

La preuve en vidéo sur le

www.COMARTEX.com

MOLA PROFILO **B+B30** MACCHINE MANUALI COMPLETA DI TASTATORE E VITE M8

*PROFILE **B+B30** WHEEL FOR HAND HELD MACHINE WITH TRACER AND SCREW M8*

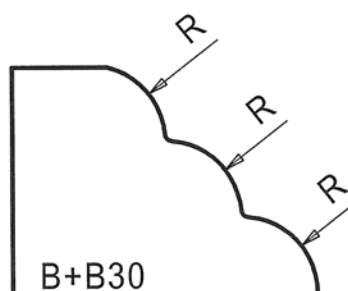

B+B30

R=10

Codice ADI <i>ADI Code</i>	Descrizione <i>Description</i>	Posizione <i>Position</i>	Codice Tastatore <i>Tracer Code</i>	Codice Vite <i>Screw Code</i>	Prezzo <i>Price</i> [€URO]
PM53027	Mola Pr. B+B D.100 S=30	00	PM14809	PM14904	590
PM54027	Mola Pr. B+B D.100 S=30	2	PM14805	PM14904	590
PM35079	Mola Pr. B+B Rubber D.125 S=30	3	-	-	142
PM35080	Mola Pr. B+B Rubber D.125 S=30	4	-	-	142
PM35081	Mola Pr. B+B Rubber D.125 S=30	5	-	-	142
PM35082	Mola Pr. B+B Rubber D.125 S=30	6	-	-	142
COSTO SET COMPLETO - <i>COMPLETE SET PRICE</i>					1748

PM57027	Mola Pr. B+B D.100 S=30	00	PM14805	PM14904	590
---------	-------------------------	----	---------	---------	-----

Mola per profilatura unica in macchina (finitura manuale)

One Step Profiling Wheel (Finishing by Hand)

COMARTEX

☎ 01 45 76 53 03

☎ 01 45 76 76 82

mail : comartex@comartex.fr

site : www.comartex.com



De la qualité, des prix et du choix...

La preuve en vidéo sur le

www.COMARTEX.com

MOLA PROFILO **B+B40** MACCHINE MANUALI COMPLETA DI TASTATORE E VITE M8

*PROFILE **B+B40** WHEEL FOR HAND HELD MACHINE WITH TRACER AND SCREW M8*

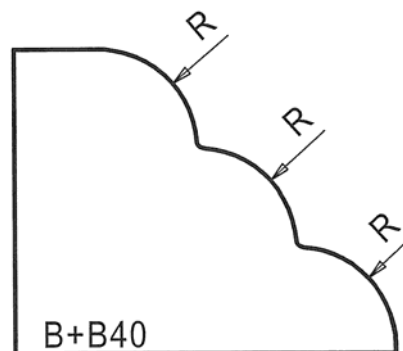

R=13

Codice ADI <i>ADI Code</i>	Descrizione <i>Description</i>	Posizione <i>Position</i>	Codice Tastatore <i>Tracer Code</i>	Codice Vite <i>Screw Code</i>	Prezzo <i>Price</i> [€URO]
PM53028	Mola Pr. B+B D.120 S=40	00	PM14809	PM14906	745
PM54028	Mola Pr. B+B D.120 S=40	2	PM14805	PM14906	745
PM35182	Mola Pr. B+B Rubber D.150 S=40	3	-	-	163
PM35183	Mola Pr. B+B Rubber D.150 S=40	4	-	-	163
PM35184	Mola Pr. B+B Rubber D.150 S=40	5	-	-	163
PM35185	Mola Pr. B+B Rubber D.150 S=40	6	-	-	163
COSTO SET COMPLETO - <i>COMPLETE SET PRICE</i>					2142

PM57028	Mola Pr. B+B D.120 S=40	00	PM14805	PM14906	745
---------	-------------------------	----	---------	---------	-----

Mola per profilatura unica in macchina (finitura manuale)

One Step Profiling Wheel (Finishing by Hand)

COMARTEX

☎ 01 45 76 53 03

☎ 01 45 76 76 82

mail : comartex@comartex.fr

site : www.comartex.com



De la qualité, des prix et du choix...

La preuve en vidéo sur le

www.COMARTEX.com

MOLA PROFILO E20 MACCHINE MANUALI COMPLETA DI TASTATORE E VITE M8

PROFILE E20 WHEEL FOR HAND HELD MACHINE WITH TRACER AND SCREW M8

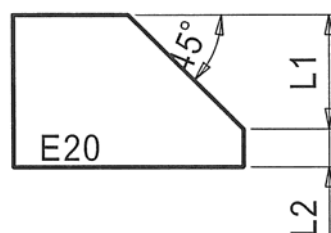

L1=14 L2=6

Codice ADI ADI Code	Descrizione Description	Posizione Position	Codice Tastatore Tracer Code	Codice Vite Screw Code	Prezzo Price [€URO]
PM53007	Mola Pr. E D.71 S=20	00	PM14809	PM14902	301
PM54007	Mola Pr. E D.71 S=20	2	PM14805	PM14902	301
PM35087	Mola Pr. E Rubber D.80 S=20	3	-	-	117
PM35088	Mola Pr. E Rubber D.80 S=20	4	-	-	117
PM35089	Mola Pr. E Rubber D.80 S=20	5	-	-	117
PM35090	Mola Pr. E Rubber D.80 S=20	6	-	-	117
COSTO SET COMPLETO - COMPLETE SET PRICE					1070

PM57007	Mola Pr. E D.71 S=20	00	PM14805	PM14902	301
Mola per profilatura unica in macchina (finitura manuale)					
One Step Profiling Wheel (Finishing by Hand)					

COMARTEX

☎ 01 45 76 53 03

☎ 01 45 76 76 82

mail : comartex@comartex.fr

site : www.comartex.com



De la qualité, des prix et du choix...

La preuve en vidéo sur le

www.COMARTEX.com

MOLA PROFILO **E30** MACCHINE MANUALI COMPLETA DI TASTATORE E VITE M8

*PROFILE **E30** WHEEL FOR HAND HELD MACHINE WITH TRACER AND SCREW M8*

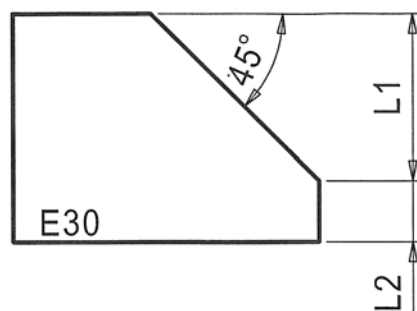

$$L1=21 \quad L2=9$$

Codice ADI <i>ADI Code</i>	Descrizione <i>Description</i>	Posizione <i>Position</i>	Codice Tastatore <i>Tracer Code</i>	Codice Vite <i>Screw Code</i>	Prezzo <i>Price</i> [€URO]
PM53008	Mola Pr. E D.87 S=30	00	PM14809	PM14904	358
PM54008	Mola Pr. E D.87 S=30	2	PM14805	PM14904	358
PM35130	Mola Pr. E Rubber D.100 S=30	3	-	-	134
PM35131	Mola Pr. E Rubber D.100 S=30	4	-	-	134
PM35132	Mola Pr. E Rubber D.100 S=30	5	-	-	134
PM35133	Mola Pr. E Rubber D.100 S=30	6	-	-	134
COSTO SET COMPLETO - <i>COMPLETE SET PRICE</i>					1252

PM57008	Mola Pr. E D.87 S=30	00	PM14805	PM14904	358
Mola per profilatura unica in macchina (finitura manuale) <i>One Step Profiling Wheel (Finishing by Hand)</i>					

COMARTEX

☎ 01 45 76 53 03

☎ 01 45 76 76 82

mail : comartex@comartex.fr

site : www.comartex.com



De la qualité, des prix et du choix...

La preuve en vidéo sur le

www.COMARTEX.com

MOLA PROFILO **F20** MACCHINE MANUALI COMPLETA DI TASTATORE E VITE M8

*PROFILE **F20** WHEEL FOR HAND HELD MACHINE WITH TRACER AND SCREW M8*

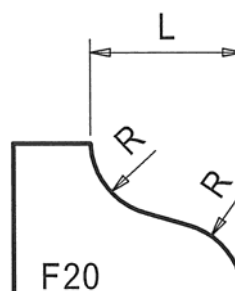

R=10 L=20

Codice ADI <i>ADI Code</i>	Descrizione <i>Description</i>	Posizione <i>Position</i>	Codice Tastatore <i>Tracer Code</i>	Codice Vite <i>Screw Code</i>	Prezzo <i>Price</i> [€URO]
PM53009	Mola Pr. F D.80 S=20	00	PM14809	PM14903	373
PM54009	Mola Pr. F D.80 S=20	2	PM14805	PM14903	373
PM35005	Mola Pr. F Rubber D.100 S=20	3	-	-	123
PM35006	Mola Pr. F Rubber D.100 S=20	4	-	-	123
PM35007	Mola Pr. F Rubber D.100 S=20	5	-	-	123
PM35008	Mola Pr. F Rubber D.100 S=20	6	-	-	123
COSTO SET COMPLETO - <i>COMPLETE SET PRICE</i>					1238

PM57009	Mola Pr. F D.80 S=20	00	PM14805	PM14903	373
Mola per profilatura unica in macchina (finitura manuale) <i>One Step Profiling Wheel (Finishing by Hand)</i>					

COMARTEX

☎ 01 45 76 53 03

☎ 01 45 76 76 82

mail : comartex@comartex.fr

site : www.comartex.com



De la qualité, des prix et du choix...

La preuve en vidéo sur le

www.COMARTEX.com

MOLA PROFILO **F30** MACCHINE MANUALI COMPLETA DI TASTATORE E VITE M8

*PROFILE **F30** WHEEL FOR HAND HELD MACHINE WITH TRACER AND SCREW M8*

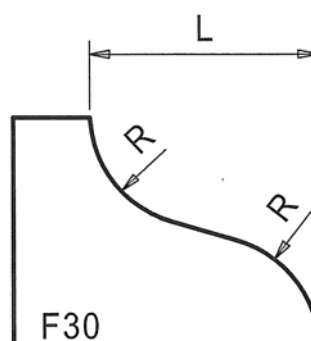

R=15 L=30

Codice ADI <i>ADI Code</i>	Descrizione <i>Description</i>	Posizione <i>Position</i>	Codice Tastatore <i>Tracer Code</i>	Codice Vite <i>Screw Code</i>	Prezzo <i>Price</i> [€URO]
PM53010	Mola Pr. F D.100 S=30	00	PM14809	PM14905	447
PM54010	Mola Pr. F D.100 S=30	2	PM14805	PM14905	447
PM35017	Mola Pr. F Rubber D.120 S=30	3	-	-	144
PM35018	Mola Pr. F Rubber D.120 S=30	4	-	-	144
PM35019	Mola Pr. F Rubber D.120 S=30	5	-	-	144
PM35020	Mola Pr. F Rubber D.120 S=30	6	-	-	144
COSTO SET COMPLETO - <i>COMPLETE SET PRICE</i>					1470

PM57010	Mola Pr. F D.100 S=30	00	PM14805	PM14905	447
Mola per profilatura unica in macchina (finitura manuale) <i>One Step Profiling Wheel (Finishing by Hand)</i>					

COMARTEX

☎ 01 45 76 53 03

☎ 01 45 76 76 82

mail : comartex@comartex.fr

site : www.comartex.com



De la qualité, des prix et du choix...

La preuve en vidéo sur le

www.COMARTEX.com

MOLA PROFILO **F40** MACCHINE MANUALI COMPLETA DI TASTATORE E VITE M8

*PROFILE **F40** WHEEL FOR HAND HELD MACHINE WITH TRACER AND SCREW M8*

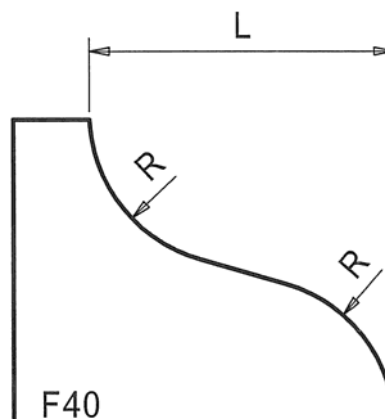

R=20 L=40

Codice ADI <i>ADI Code</i>	Descrizione <i>Description</i>	Posizione <i>Position</i>	Codice Tastatore <i>Tracer Code</i>	Codice Vite <i>Screw Code</i>	Prezzo <i>Price</i> [€URO]
PM53011	Mola Pr. F D.120 S=40	00	PM14809	PM14906	518
PM54011	Mola Pr. F D.120 S=40	2	PM14805	PM14906	518
PM35134	Mola Pr. F Rubber D.140 S=40	3	-	-	162
PM35135	Mola Pr. F Rubber D.140 S=40	4	-	-	162
PM35136	Mola Pr. F Rubber D.140 S=40	5	-	-	162
PM35137	Mola Pr. F Rubber D.140 S=40	6	-	-	162
COSTO SET COMPLETO - <i>COMPLETE SET PRICE</i>					1470

PM57011	Mola Pr. F D.120 S=40	00	PM14805	PM14906	518
Mola per profilatura unica in macchina (finitura manuale) <i>One Step Profiling Wheel (Finishing by Hand)</i>					

COMARTEX

☎ 01 45 76 53 03

☎ 01 45 76 76 82

mail : comartex@comartex.fr

site : www.comartex.com



De la qualité, des prix et du choix...

La preuve en vidéo sur le

www.COMARTEX.com

MOLA PROFILO **FS30** MACCHINE MANUALI COMPLETA DI TASTATORE E VITE M8

*PROFILE **FS30** WHEEL FOR HAND HELD MACHINE WITH TRACER AND SCREW M8*

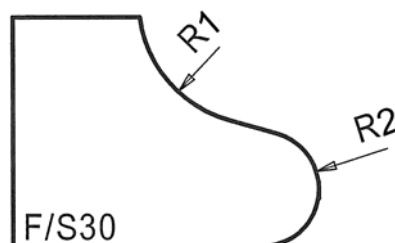

R1 = 16 mm R2 = 7,5 mm

Codice ADI <i>ADI Code</i>	Descrizione <i>Description</i>	Posizione <i>Position</i>	Codice Tastatore <i>Tracer Code</i>	Codice Vite <i>Screw Code</i>	Prezzo <i>Price</i> [€URO]
PM53136	Mola Pr. F/S D.87 S=30	00	PM14804	PM14903	684
PM54136	Mola Pr. F/S D.87 S=30	2	PM14801	PM14903	684
PM35260	Mola Pr. F/S Rubber D.119 S=30	3	-	-	134
PM35261	Mola Pr. F/S Rubber D.119 S=30	4	-	-	134
PM35262	Mola Pr. F/S Rubber D.119 S=30	5	-	-	134
PM35263	Mola Pr. F/S Rubber D.119 S=30	6	-	-	134
COSTO SET COMPLETO - <i>COMPLETE SET PRICE</i>					1904

PM57136	Mola Pr. F D.87 S=30	00	PM14801	PM14903	684
Mola per profilatura unica in macchina (finitura manuale) <i>One Step Profiling Wheel (Finishing by Hand)</i>					

COMARTEX

☎ 01 45 76 53 03

☎ 01 45 76 76 82

mail : comartex@comartex.fr

site : www.comartex.com



De la qualité, des prix et du choix...

La preuve en vidéo sur le

www.COMARTEX.com

**MOLA PROFILO F + V30 MACCHINE MANUALI
COMPLETA DI TASTATORE E VITE M8**
**PROFILE F + V30 WHEEL FOR HAND HELD MACHINE
WITH TRACER AND SCREW M8**

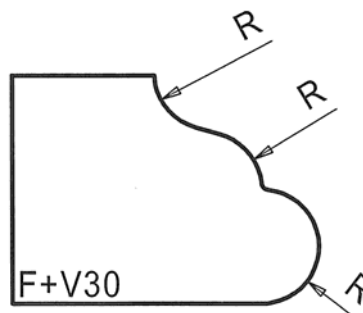

R=7,5

Codice ADI <i>ADI Code</i>	Descrizione <i>Description</i>	Posizione <i>Position</i>	Codice Tastatore <i>Tracer Code</i>	Codice Vite <i>Screw Code</i>	Prezzo <i>Price</i> [€URO]
PM53108	Mola Pr. F+V D.83 S=30	00	PM14804	PM14903	680
PM54108	Mola Pr. F+V D.83 S=30	2	PM14801	PM14903	680
PM35190	Mola Pr. F+V Rubber D.100 S=30	3	-	-	159
PM35191	Mola Pr. F+V Rubber D.100 S=30	4	-	-	159
PM35192	Mola Pr. F+V Rubber D.100 S=30	5	-	-	159
PM35193	Mola Pr. F+V Rubber D.100 S=30	6	-	-	159
COSTO SET COMPLETO - <i>COMPLETE SET PRICE</i>					1996

PM57108	Mola Pr. F+V D.83 S=30	00	PM14801	PM14903	680
Mola per profilatura unica in macchina (finitura manuale) <i>One Step Profiling Wheel (Finishing by Hand)</i>					

COMARTEX

☎ 01 45 76 53 03

☎ 01 45 76 76 82

mail : comartex@comartex.fr

site : www.comartex.com



De la qualité, des prix et du choix...

La preuve en vidéo sur le

www.COMARTEX.com

**MOLA PROFILO F + V40 MACCHINE MANUALI
COMPLETA DI TASTATORE E VITE M8**
**PROFILE F + V40 WHEEL FOR HAND HELD MACHINE
WITH TRACER AND SCREW M8**

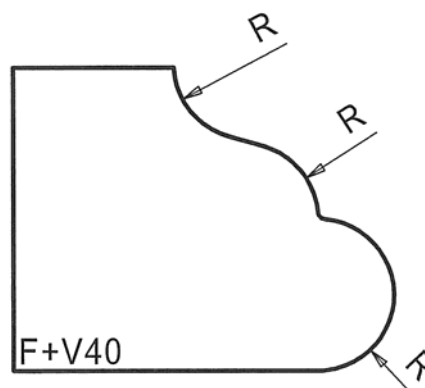

R=10

Codice ADI <i>ADI Code</i>	Descrizione <i>Description</i>	Posizione <i>Position</i>	Codice Tastatore <i>Tracer Code</i>	Codice Vite <i>Screw Code</i>	Prezzo <i>Price</i> [€URO]
PM53110	Mola Pr. F+V D.98 S=40	00	PM14804	PM14904	702
PM54110	Mola Pr. F+V D.98 S=40	2	PM14801	PM14904	702
PM35067	Mola Pr. F+V Rubber D.120 S=40	3	-	-	174
PM35068	Mola Pr. F+V Rubber D.120 S=40	4	-	-	174
PM35069	Mola Pr. F+V Rubber D.120 S=40	5	-	-	174
PM35070	Mola Pr. F+V Rubber D.120 S=40	6	-	-	174
COSTO SET COMPLETO - <i>COMPLETE SET PRICE</i>					2100

PM57110	Mola Pr. F+V D.98 S=40	00	PM14801	PM14904	702
Mola per profilatura unica in macchina (finitura manuale) <i>One Step Profiling Wheel (Finishing by Hand)</i>					

COMARTEX

☎ 01 45 76 53 03

☎ 01 45 76 76 82

mail : comartex@comartex.fr

site : www.comartex.com



De la qualité, des prix et du choix...

La preuve en vidéo sur le

www.COMARTEX.com

**MOLA PROFILO F + Z30 MACCHINE MANUALI
COMPLETA DI TASTATORE E VITE M8**
**PROFILE F + Z30 WHEEL FOR HAND HELD MACHINE
WITH TRACER AND SCREW M8**

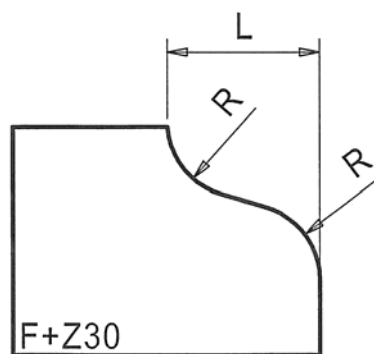

L=20 R=10

Codice ADI <i>ADI Code</i>	Descrizione <i>Description</i>	Posizione <i>Position</i>	Codice Tastatore <i>Tracer Code</i>	Codice Vite <i>Screw Code</i>	Prezzo <i>Price</i> [€URO]
PM53114	Mola Pr. F+Z D.80 S=30	00	PM14809	PM14903	373
PM54114	Mola Pr. F+Z D.80 S=30	2	PM14805	PM14903	373
PM35121	Mola Pr. F+Z Rubber D.105 S=30	3	-	-	134
PM35122	Mola Pr. F+Z Rubber D.105 S=30	4	-	-	134
PM35123	Mola Pr. F+Z Rubber D.105 S=30	5	-	-	134
PM35124	Mola Pr. F+Z Rubber D.105 S=30	6	-	-	134
COSTO SET COMPLETO - <i>COMPLETE SET PRICE</i>					1282

PM57114	Mola Pr. F+Z D.80 S=30	00	PM14805	PM14903	373
Mola per profilatura unica in macchina (finitura manuale) <i>One Step Profiling Wheel (Finishing by Hand)</i>					

COMARTEX

☎ 01 45 76 53 03

☎ 01 45 76 76 82

mail : comartex@comartex.fr

site : www.comartex.com



De la qualité, des prix et du choix...

La preuve en vidéo sur le

www.COMARTEX.com

**MOLA PROFILO F + Z40 MACCHINE MANUALI
COMPLETA DI TASTATORE E VITE M8**
**PROFILE F + Z40 WHEEL FOR HAND HELD MACHINE
WITH TRACER AND SCREW M8**

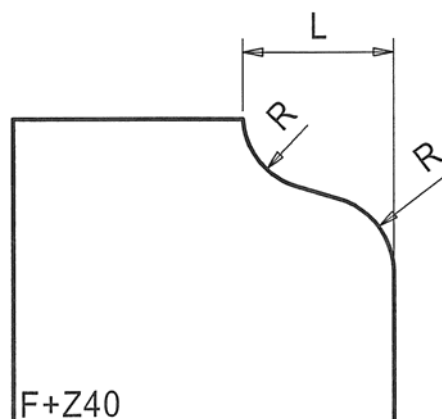

L=20 R=10

Codice ADI ADI Code	Descrizione Description	Posizione Position	Codice Tastatore Tracer Code	Codice Vite Screw Code	Prezzo Price [€URO]
PM53115	Mola Pr. F+Z D.80 S=40	00	PM14809	PM14903	373
PM54115	Mola Pr. F+Z D.80 S=40	2	PM14805	PM14903	373
PM35170	Mola Pr. F+Z Rubber D.105 S=40	3	-	-	153
PM35171	Mola Pr. F+Z Rubber D.105 S=40	4	-	-	153
PM35172	Mola Pr. F+Z Rubber D.105 S=40	5	-	-	153
PM35173	Mola Pr. F+Z Rubber D.105 S=40	6	-	-	153
COSTO SET COMPLETO - COMPLETE SET PRICE					1358

PM57115	Mola Pr. F+Z D.80 S=40	00	PM14805	PM14903	373
Mola per profilatura unica in macchina (finitura manuale) One Step Profiling Wheel (Finishing by Hand)					

COMARTEX

☎ 01 45 76 53 03

☎ 01 45 76 76 82

mail : comartex@comartex.fr

site : www.comartex.com



De la qualité, des prix et du choix...

La preuve en vidéo sur le

www.COMARTEX.com

MOLA PROFILO H20 MACCHINE MANUALI COMPLETA DI TASTATORE E VITE M8

PROFILE H20 WHEEL FOR HAND HELD MACHINE WITH TRACER AND SCREW M8

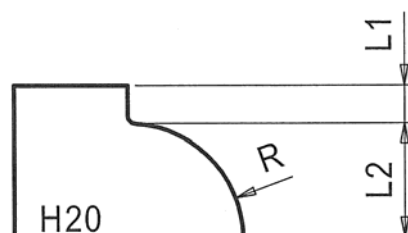

L1=15 L2=5 R=15

Codice ADI ADI Code	Descrizione Description	Posizione Position	Codice Tastatore Tracer Code	Codice Vite Screw Code	Prezzo Price [€URO]
PM53012	Mola Pr. H D.70 S=20	00	PM14809	PM14902	298
PM54012	Mola Pr. H D.70 S=20	2	PM14805	PM14902	298
PM35057	Mola Pr. H Rubber D.90 S=20	3	-	-	119
PM35058	Mola Pr. H Rubber D.90 S=20	4	-	-	119
PM35059	Mola Pr. H Rubber D.90 S=20	5	-	-	119
PM35060	Mola Pr. H Rubber D.90 S=20	6	-	-	119
COSTO SET COMPLETO - COMPLETE SET PRICE					1072

PM57012	Mola Pr. H D.70 S=20	00	PM14805	PM14902	298
Mola per profilatura unica in macchina (finitura manuale)					
One Step Profiling Wheel (Finishing by Hand)					

COMARTEX

☎ 01 45 76 53 03

☎ 01 45 76 76 82

mail : comartex@comartex.fr

site : www.comartex.com



De la qualité, des prix et du choix...

La preuve en vidéo sur le

www.COMARTEX.com

MOLA PROFILO **H30** MACCHINE MANUALI COMPLETA DI TASTATORE E VITE M8

*PROFILE **H30** WHEEL FOR HAND HELD MACHINE WITH TRACER AND SCREW M8*

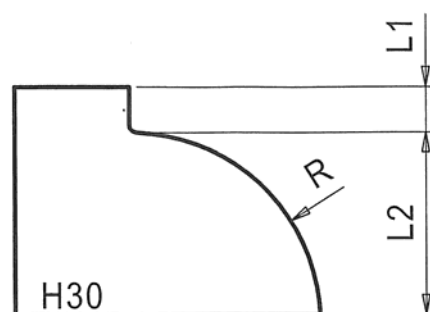

$$L1=6 \quad L2=24 \quad R=25$$

Codice ADI <i>ADI Code</i>	Descrizione <i>Description</i>	Posizione <i>Position</i>	Codice Tastatore <i>Tracer Code</i>	Codice Vite <i>Screw Code</i>	Prezzo <i>Price</i> [€URO]
PM53013	Mola Pr. H D.90 S=30	00	PM14809	PM14903	362
PM54013	Mola Pr. H D.90 S=30	2	PM14805	PM14903	362
PM35038	Mola Pr. H Rubber D.110 S=30	3	-	-	131
PM35039	Mola Pr. H Rubber D.110 S=30	4	-	-	131
PM35040	Mola Pr. H Rubber D.110 S=30	5	-	-	131
PM35041	Mola Pr. H Rubber D.110 S=30	6	-	-	131
COSTO SET COMPLETO - <i>COMPLETE SET PRICE</i>					1248

PM57013	Mola Pr. H D.90 S=30	00	PM14805	PM14903	362
Mola per profilatura unica in macchina (finitura manuale)					
<i>One Step Profiling Wheel (Finishing by Hand)</i>					

COMARTEX

☎ 01 45 76 53 03

☎ 01 45 76 76 82

mail : comartex@comartex.fr

site : www.comartex.com



De la qualité, des prix et du choix...

La preuve en vidéo sur le

www.COMARTEX.com

MOLA PROFILO I20 MACCHINE MANUALI COMPLETA DI TASTATORE E VITE M8

PROFILE I20 WHEEL FOR HAND HELD MACHINE WITH TRACER AND SCREW M8

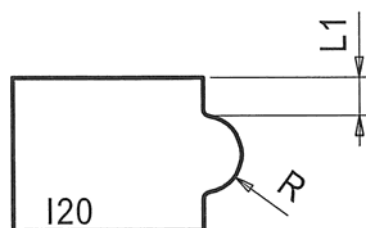

L1=5 L2=10 R=5

Codice ADI ADI Code	Descrizione Description	Posizione Position	Codice Tastatore Tracer Code	Codice Vite Screw Code	Prezzo Price [€URO]
PM53045	Mola Pr. I D.50 S=20	00	PM14809	PM14902	421
PM54045	Mola Pr. I D.50 S=20	2	PM14805	PM14902	421
PM35138	Mola Pr. I Rubber D.100 S=20	3	-	-	124
PM35139	Mola Pr. I Rubber D.100 S=20	4	-	-	124
PM35140	Mola Pr. I Rubber D.100 S=20	5	-	-	124
PM35141	Mola Pr. I Rubber D.100 S=20	6	-	-	124
COSTO SET COMPLETO - COMPLETE SET PRICE					1338

PM57045	Mola Pr. I D.50 S=20	00	PM14805	PM14902	421
Mola per profilatura unica in macchina (finitura manuale)					
<i>One Step Profiling Wheel (Finishing by Hand)</i>					

COMARTEX

☎ 01 45 76 53 03

☎ 01 45 76 76 82

mail : comartex@comartex.fr

site : www.comartex.com



De la qualité, des prix et du choix...

La preuve en vidéo sur le

www.COMARTEX.com

MOLA PROFILO I30 MACCHINE MANUALI COMPLETA DI TASTATORE E VITE M8

PROFILE I30 WHEEL FOR HAND HELD MACHINE WITH TRACER AND SCREW M8

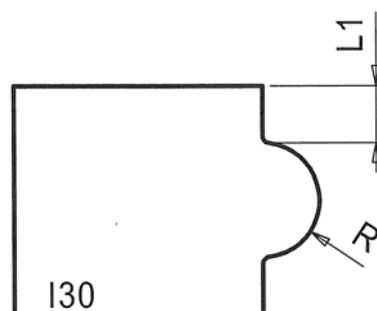

$$L1 = 7,5 \quad L2 = 15 \quad R = 7,5$$

Codice ADI ADI Code	Descrizione Description	Posizione Position	Codice Tastatore Tracer Code	Codice Vite Screw Code	Prezzo Price [€URO]
PM53046	Mola Pr. I D.55 S=30	00	PM14809	PM14902	499
PM54046	Mola Pr. I D.55 S=30	2	PM14805	PM14902	499
PM35142	Mola Pr. I Rubber D.100 S=30	3	-	-	150
PM35143	Mola Pr. I Rubber D.100 S=30	4	-	-	150
PM35144	Mola Pr. I Rubber D.100 S=30	5	-	-	150
PM35145	Mola Pr. I Rubber D.100 S=30	6	-	-	150
COSTO SET COMPLETO - COMPLETE SET PRICE					1598

PM57046	Mola Pr. I D.55 S=30	00	PM14805	PM14902	499
Mola per profilatura unica in macchina (finitura manuale)					
<i>One Step Profiling Wheel (Finishing by Hand)</i>					

COMARTEX

☎ 01 45 76 53 03

☎ 01 45 76 76 82

mail : comartex@comartex.fr

site : www.comartex.com



De la qualité, des prix et du choix...

La preuve en vidéo sur le

www.COMARTEX.com

MOLA PROFILO L20 MACCHINE MANUALI COMPLETA DI TASTATORE E VITE M8

PROFILE L20 WHEEL FOR HAND HELD MACHINE WITH TRACER AND SCREW M8

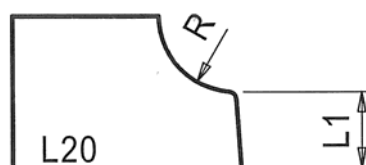

R=10

Codice ADI ADI Code	Descrizione Description	Posizione Position	Codice Tastatore Tracer Code	Codice Vite Screw Code	Prezzo Price [€URO]
PM53049	Mola Pr. L D.61 S=20	00	PM14809	PM14903	370
PM54049	Mola Pr. L D.61 S=20	2	PM14805	PM14903	370
PM35146	Mola Pr. L Rubber D.82 S=20	3	-	-	119
PM35147	Mola Pr. L Rubber D.82 S=20	4	-	-	119
PM35148	Mola Pr. L Rubber D.82 S=20	5	-	-	119
PM35149	Mola Pr. L Rubber D.82 S=20	6	-	-	119
COSTO SET COMPLETO - COMPLETE SET PRICE					1216

PM57049 Mola Pr. L D.61 S=20 00 PM14805 PM14903 370

Mola per profilatura unica in macchina (finitura manuale)

One Step Profiling Wheel (Finishing by Hand)

COMARTEX

☎ 01 45 76 53 03

☎ 01 45 76 76 82

mail : comartex@comartex.fr

site : www.comartex.com



De la qualité, des prix et du choix...

La preuve en vidéo sur le

www.COMARTEX.com

MOLA PROFILO L30 MACCHINE MANUALI COMPLETA DI TASTATORE E VITE M8

PROFILE L30 WHEEL FOR HAND HELD MACHINE WITH TRACER AND SCREW M8

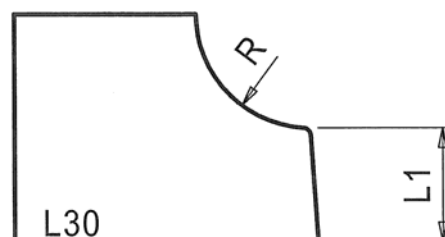

R=15

Codice ADI ADI Code	Descrizione Description	Posizione Position	Codice Tastatore Tracer Code	Codice Vite Screw Code	Prezzo Price [€URO]
PM53050	Mola Pr. L D.72 S=30	00	PM14890	PM14905	438
PM54050	Mola Pr. L D.72 S=30	2	PM14805	PM14905	438
PM35117	Mola Pr. L Rubber D.100 S=30	3	-	-	139
PM35118	Mola Pr. L Rubber D.100 S=30	4	-	-	139
PM35119	Mola Pr. L Rubber D.100 S=30	5	-	-	139
PM35120	Mola Pr. L Rubber D.100 S=30	6	-	-	139
COSTO SET COMPLETO - COMPLETE SET PRICE					1432

PM57050	Mola Pr. L D.72 S=30	00	PM14805	PM14905	438
Mola per profilatura unica in macchina (finitura manuale)					
One Step Profiling Wheel (Finishing by Hand)					

COMARTEX

☎ 01 45 76 53 03

☎ 01 45 76 76 82

mail : comartex@comartex.fr

site : www.comartex.com



De la qualité, des prix et du choix...

La preuve en vidéo sur le

www.COMARTEX.com

MOLA PROFILO **M30** MACCHINE MANUALI COMPLETA DI TASTATORE E VITE M8

PROFILE **M30** WHEEL FOR HAND HELD MACHINE WITH TRACER AND SCREW M8

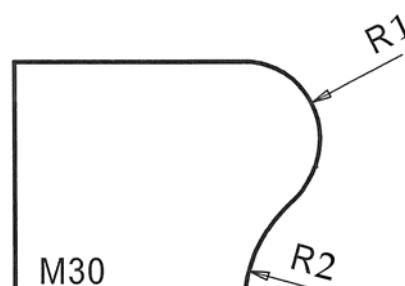

$$R1 = 11,25 \quad R2 = 18,75$$

Codice ADI <i>ADI Code</i>	Descrizione <i>Description</i>	Posizione <i>Position</i>	Codice Tastatore <i>Tracer Code</i>	Codice Vite <i>Screw Code</i>	Prezzo <i>Price</i> [€URO]
PM53054	Mola Pr. M D.66 S=30	00	PM14804	PM14903	576
PM54054	Mola Pr. M D.66 S=30	2	PM14801	PM14903	576
PM35216	Mola Pr. M Rubber D.90 S=30	3	-	-	153
PM35217	Mola Pr. M Rubber D.90 S=30	4	-	-	153
PM35218	Mola Pr. M Rubber D.90 S=30	5	-	-	153
PM35219	Mola Pr. M Rubber D.90 S=30	6	-	-	153
COSTO SET COMPLETO - <i>COMPLETE SET PRICE</i>					1764

PM57054	Mola Pr. M D.66 S=30	00	PM14801	PM14903	576
Mola per profilatura unica in macchina (finitura manuale)					
<i>One Step Profiling Wheel (Finishing by Hand)</i>					

COMARTEX

☎ 01 45 76 53 03

☎ 01 45 76 76 82

mail : comartex@comartex.fr

site : www.comartex.com



De la qualité, des prix et du choix...

La preuve en vidéo sur le

www.COMARTEX.com

MOLA PROFILO **O20** MACCHINE MANUALI COMPLETA DI TASTATORE E VITE M8

PROFILE **O20** WHEEL FOR HAND HELD MACHINE WITH TRACER AND SCREW M8

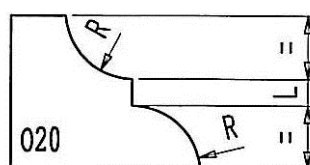

$$R = 9 \quad L = 3,5$$

Codice ADI <i>ADI Code</i>	Descrizione <i>Description</i>	Posizione <i>Position</i>	Codice Tastatore <i>Tracer Code</i>	Codice Vite <i>Screw Code</i>	Prezzo <i>Price</i> [€URO]
PM53061	Mola Pr. O D.76 S=20	00	PM14809	PM14903	481
PM54061	Mola Pr. O D.76 S=20	2	PM14805	PM14903	481
PM35109	Mola Pr. O Rubber D.115 S=20	3	-	-	143
PM35110	Mola Pr. O Rubber D.115 S=20	4	-	-	143
PM35111	Mola Pr. O Rubber D.115 S=20	5	-	-	143
PM35112	Mola Pr. O Rubber D.115 S=20	6	-	-	143
COSTO SET COMPLETO - <i>COMPLETE SET PRICE</i>					1534

PM57061	Mola Pr. O D.76 S=20	00	PM14805	PM14903	481
Mola per profilatura unica in macchina (finitura manuale)					
<i>One Step Profiling Wheel (Finishing by Hand)</i>					

COMARTEX

☎ 01 45 76 53 03

☎ 01 45 76 76 82

mail : comartex@comartex.fr

site : www.comartex.com



De la qualité, des prix et du choix...

La preuve en vidéo sur le

www.COMARTEX.com

MOLA PROFILO **O30** MACCHINE MANUALI COMPLETA DI TASTATORE E VITE M8

PROFILE **O30** WHEEL FOR HAND HELD MACHINE WITH TRACER AND SCREW M8

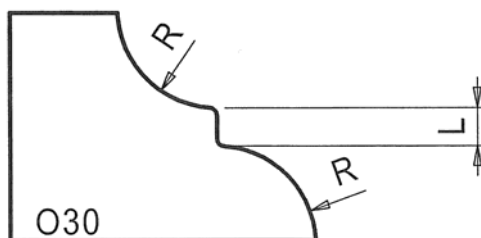

R=13 L=5

Codice ADI <i>ADI Code</i>	Descrizione <i>Description</i>	Posizione <i>Position</i>	Codice Tastatore <i>Tracer Code</i>	Codice Vite <i>Screw Code</i>	Prezzo <i>Price</i> [€URO]
PM53062	Mola Pr. O D.92 S=30	00	PM14809	PM14905	584
PM54062	Mola Pr. O D.92 S=30	2	PM14805	PM14905	584
PM35154	Mola Pr. O Rubber D.115 S=30	3	-	-	161
PM35155	Mola Pr. O Rubber D.115 S=30	4	-	-	161
PM35156	Mola Pr. O Rubber D.115 S=30	5	-	-	161
PM35157	Mola Pr. O Rubber D.115 S=30	6	-	-	161
COSTO SET COMPLETO - <i>COMPLETE SET PRICE</i>					1812

PM57062	Mola Pr. O D.92 S=30	00	PM14805	PM14905	584
Mola per profilatura unica in macchina (finitura manuale)					
<i>One Step Profiling Wheel (Finishing by Hand)</i>					

COMARTEX

☎ 01 45 76 53 03

☎ 01 45 76 76 82

mail : comartex@comartex.fr

site : www.comartex.com



De la qualité, des prix et du choix...

La preuve en vidéo sur le

www.COMARTEX.com

MOLA PROFILO Q20 MACCHINE MANUALI COMPLETA DI TASTATORE E VITE M8

PROFILE Q20 WHEEL FOR HAND HELD MACHINE WITH TRACER AND SCREW M8

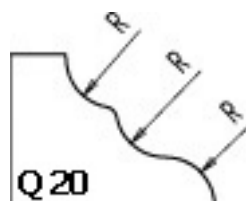

R=6,5

Codice ADI <i>ADI Code</i>	Descrizione <i>Description</i>	Posizione <i>Position</i>	Codice Tastatore <i>Tracer Code</i>	Codice Vite <i>Screw Code</i>	Prezzo <i>Price</i> [€URO]
PM53069	Mola Pr. Q D.79 S=20	00	PM14809	PM14903	506
PM54069	Mola Pr. Q D.79 S=20	2	PM14805	PM14903	506
PM35158	Mola Pr. Q Rubber D.105 S=20	3	-	-	129
PM35159	Mola Pr. Q Rubber D.105 S=20	4	-	-	129
PM35160	Mola Pr. Q Rubber D.105 S=20	5	-	-	129
PM35161	Mola Pr. Q Rubber D.105 S=20	6	-	-	129
COSTO SET COMPLETO - <i>COMPLETE SET PRICE</i>					1.528

PM57069	Mola Pr. Q D.79 S=20	00	PM14805	PM14903	506
Mola per profilatura unica in macchina (finitura manuale)					
<i>One Step Profiling Wheel (Finishing by Hand)</i>					

COMARTEX

☎ 01 45 76 53 03

☎ 01 45 76 76 82

mail : comartex@comartex.fr

site : www.comartex.com



De la qualité, des prix et du choix...

La preuve en vidéo sur le

www.COMARTEX.com

MOLA PROFILO Q30 MACCHINE MANUALI COMPLETA DI TASTATORE E VITE M8

PROFILE Q30 WHEEL FOR HAND HELD MACHINE WITH TRACER AND SCREW M8

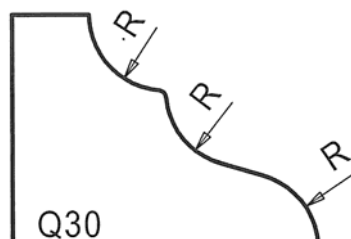

R=10

Codice ADI ADI Code	Descrizione Description	Posizione Position	Codice Tastatore Tracer Code	Codice Vite Screw Code	Prezzo Price [€URO]
PM53070	Mola Pr. Q D.100 S=30	00	PM14809	PM14904	621
PM54070	Mola Pr. Q D.100 S=30	2	PM14805	PM14904	621
PM35162	Mola Pr. Q Rubber D.120 S=30	3	-	-	148
PM35163	Mola Pr. Q Rubber D.120 S=30	4	-	-	148
PM35164	Mola Pr. Q Rubber D.120 S=30	5	-	-	148
PM35165	Mola Pr. Q Rubber D.120 S=30	6	-	-	148
COSTO SET COMPLETO - COMPLETE SET PRICE					1834

PM57070	Mola Pr. Q D.100 S=30	00	PM14805	PM14904	621
Mola per profilatura unica in macchina (finitura manuale)					
One Step Profiling Wheel (Finishing by Hand)					

COMARTEX

☎ 01 45 76 53 03

☎ 01 45 76 76 82

mail : comartex@comartex.fr

site : www.comartex.com



De la qualité, des prix et du choix...

La preuve en vidéo sur le

www.COMARTEX.com

MOLA PROFILO SM30 MACCHINE MANUALI COMPLETA DI TASTATORE E VITE M8

PROFILE SM30 WHEEL FOR HAND HELD MACHINE WITH TRACER AND SCREW M8

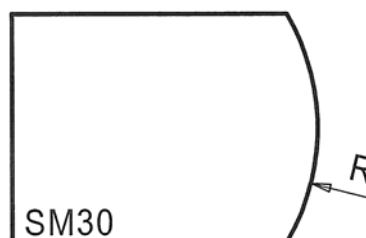

R = 30 mm S=30 mm

Codice ADI ADI Code	Descrizione Description	Posizione Position	Codice Tastatore Tracer Code	Codice Vite Screw Code	Prezzo Price [€URO]
PM53166	Mola Pr. SM D.50 S=30	00	PM14814	PM14903	465
PM54166	Mola Pr. SM D.50 S=30	2	PM14815	PM14903	465
PM35304	Mola Pr. SM Rubber D.80 S=30	3	-	-	124
PM35305	Mola Pr. SM Rubber D.80 S=30	4	-	-	124
PM35306	Mola Pr. SM Rubber D.80 S=30	5	-	-	124
PM35307	Mola Pr. SM Rubber D.80 S=30	6	-	-	124
COSTO SET COMPLETO - COMPLETE SET PRICE					1426

PM57166	Mola Pr. SM D.50 S=30	00	PM14815	PM14903	465
Mola per profilatura unica in macchina (finitura manuale)					
<i>One Step Profiling Wheel (Finishing by Hand)</i>					

COMARTEX

☎ 01 45 76 53 03

☎ 01 45 76 76 82

mail : comartex@comartex.fr

site : www.comartex.com



De la qualité, des prix et du choix...

La preuve en vidéo sur le

www.COMARTEX.com

MOLA PROFILO T20 MACCHINE MANUALI COMPLETA DI TASTATORE E VITE M8

PROFILE T20 WHEEL FOR HAND HELD MACHINE WITH TRACER AND SCREW M8

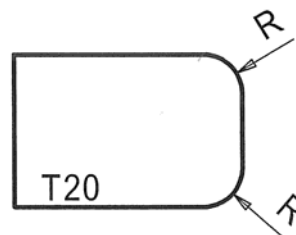

R=5

Codice ADI ADI Code	Descrizione Description	Posizione Position	Codice Tastatore Tracer Code	Codice Vite Screw Code	Prezzo Price [€URO]
PM53014	Mola Pr. T D.57 S=20	00	PM14804	PM14902	405
PM54014	Mola Pr. T D.57 S=20	2	PM14801	PM14902	405
PM35091	Mola Pr. T Rubber D.80 S=20	3	-	-	108
PM35061	Mola Pr. T Rubber D.80 S=20	4	-	-	108
PM35062	Mola Pr. T Rubber D.80 S=20	5	-	-	108
PM35063	Mola Pr. T Rubber D.80 S=20	6	-	-	108
COSTO SET COMPLETO - COMPLETE SET PRICE					1242

PM57014	Mola Pr. T D.57 S=20	00	PM14801	PM14902	405
Mola per profilatura unica in macchina (finitura manuale)					
<i>One Step Profiling Wheel (Finishing by Hand)</i>					

COMARTEX

☎ 01 45 76 53 03

☎ 01 45 76 76 82

mail : comartex@comartex.fr

site : www.comartex.com



De la qualité, des prix et du choix...

La preuve en vidéo sur le

www.COMARTEX.com

MOLA PROFILO T30 MACCHINE MANUALI COMPLETA DI TASTATORE E VITE M8

PROFILE T30 WHEEL FOR HAND HELD MACHINE WITH TRACER AND SCREW M8

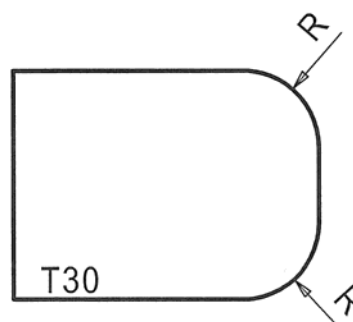

R=10

Codice ADI ADI Code	Descrizione Description	Posizione Position	Codice Tastatore Tracer Code	Codice Vite Screw Code	Prezzo Price [€URO]
PM53015	Mola Pr. T D.66 S=30	00	PM14804	PM14902	465
PM54015	Mola Pr. T D.66 S=30	2	PM14801	PM14902	465
PM35026	Mola Pr. T Rubber D.100 S=30	3	-	-	123
PM35027	Mola Pr. T Rubber D.100 S=30	4	-	-	123
PM35028	Mola Pr. T Rubber D.100 S=30	5	-	-	123
PM35029	Mola Pr. T Rubber D.100 S=30	6	-	-	123
COSTO SET COMPLETO - COMPLETE SET PRICE					1422

PM57015	Mola Pr. T D.66 S=30	00	PM14801	PM14902	465
Mola per profilatura unica in macchina (finitura manuale)					
One Step Profiling Wheel (Finishing by Hand)					

COMARTEX

☎ 01 45 76 53 03

☎ 01 45 76 76 82

mail : comartex@comartex.fr

site : www.comartex.com



De la qualité, des prix et du choix...

La preuve en vidéo sur le

www.COMARTEX.com

MOLA PROFILO **V20** MACCHINE MANUALI COMPLETA DI TASTATORE E VITE M8

*PROFILE **V20** WHEEL FOR HAND HELD MACHINE WITH TRACER AND SCREW M8*



R=10

Codice ADI <i>ADI Code</i>	Descrizione <i>Description</i>	Posizione <i>Position</i>	Codice Tastatore <i>Tracer Code</i>	Codice Vite <i>Screw Code</i>	Prezzo <i>Price</i> [€URO]
PM53016	Mola Pr. V D.66 S=20	00	PM14804	PM14902	331
PM54016	Mola Pr. V D.66 S=20	2	PM14801	PM14902	331
PM35030	Mola Pr. V Rubber D.100 S=20	3	-	-	100
PM35031	Mola Pr. V Rubber D.100 S=20	4	-	-	100
PM35032	Mola Pr. V Rubber D.100 S=20	5	-	-	100
PM35033	Mola Pr. V Rubber D.100 S=20	6	-	-	100
COSTO SET COMPLETO - <i>COMPLETE SET PRICE</i>					1062

PM57016	Mola Pr. V D.66 S=20	00	PM14801	PM14902	331
Mola per profilatura unica in macchina (finitura manuale) <i>One Step Profiling Wheel (Finishing by Hand)</i>					

COMARTEX

☎ 01 45 76 53 03

☎ 01 45 76 76 82

mail : comartex@comartex.fr

site : www.comartex.com



De la qualité, des prix et du choix...

La preuve en vidéo sur le

www.COMARTEX.com

MOLA PROFILO **V30** MACCHINE MANUALI COMPLETA DI TASTATORE E VITE M8

*PROFILE **V30** WHEEL FOR HAND HELD MACHINE WITH TRACER AND SCREW M8*



R=15

Codice ADI <i>ADI Code</i>	Descrizione <i>Description</i>	Posizione <i>Position</i>	Codice Tastatore <i>Tracer Code</i>	Codice Vite <i>Screw Code</i>	Prezzo <i>Price</i> [€URO]
PM53017	Mola Pr. V D.76 S=30	00	PM14804	PM14902	368
PM54017	Mola Pr. V D.76 S=30	2	PM14801	PM14902	368
PM35009	Mola Pr. V Rubber D.105 S=30	3	-	-	115
PM35010	Mola Pr. V Rubber D.105 S=30	4	-	-	115
PM35011	Mola Pr. V Rubber D.105 S=30	5	-	-	115
PM35012	Mola Pr. V Rubber D.105 S=30	6	-	-	115
COSTO SET COMPLETO - COMPLETE SET PRICE					1196

PM57017	Mola Pr. V D.76 S=30	00	PM14801	PM14902	368
Mola per profilatura unica in macchina (finitura manuale)					
<i>One Step Profiling Wheel (Finishing by Hand)</i>					

COMARTEX

☎ 01 45 76 53 03

☎ 01 45 76 76 82

mail : comartex@comartex.fr

site : www.comartex.com



De la qualité, des prix et du choix...

La preuve en vidéo sur le

www.COMARTEX.com

MOLA PROFILO **V40** MACCHINE MANUALI COMPLETA DI TASTATORE E VITE M8

*PROFILE **V40** WHEEL FOR HAND HELD MACHINE WITH TRACER AND SCREW M8*

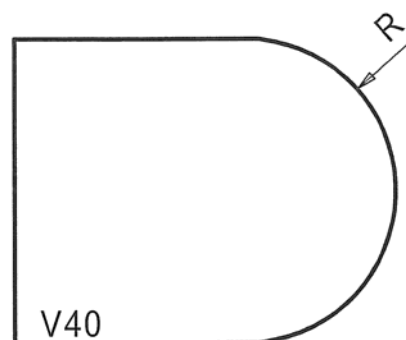

R=20

Codice ADI <i>ADI Code</i>	Descrizione <i>Description</i>	Posizione <i>Position</i>	Codice Tastatore <i>Tracer Code</i>	Codice Vite <i>Screw Code</i>	Prezzo <i>Price</i> [€URO]
PM53018	Mola Pr. V D.86 S=40	00	PM14804	PM14904	449
PM54018	Mola Pr. V D.86 S=40	2	PM14801	PM14904	449
PM35013	Mola Pr. V Rubber D.116 S=40	3	-	-	131
PM35014	Mola Pr. V Rubber D.116 S=40	4	-	-	131
PM35015	Mola Pr. V Rubber D.116 S=40	5	-	-	131
PM35016	Mola Pr. V Rubber D.116 S=40	6	-	-	131
COSTO SET COMPLETO - <i>COMPLETE SET PRICE</i>					1422

PM57018	Mola Pr. V D.86 S=40	00	PM14801	PM14904	449
Mola per profilatura unica in macchina (finitura manuale) <i>One Step Profiling Wheel (Finishing by Hand)</i>					

COMARTEX

☎ 01 45 76 53 03

☎ 01 45 76 76 82

mail : comartex@comartex.fr

site : www.comartex.com



De la qualité, des prix et du choix...

La preuve en vidéo sur le

www.COMARTEX.com

MOLA PROFILO **V50** MACCHINE MANUALI COMPLETA DI TASTATORE E VITE M8

*PROFILE **V50** WHEEL FOR HAND HELD MACHINE WITH TRACER AND SCREW M8*

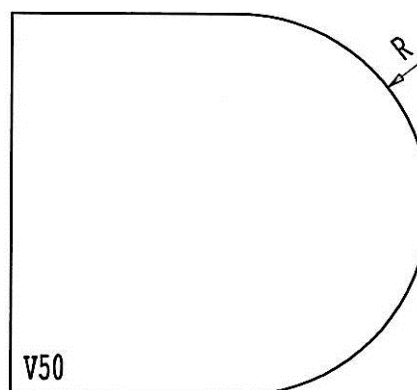

R=25

Codice ADI <i>ADI Code</i>	Descrizione <i>Description</i>	Posizione <i>Position</i>	Codice Tastatore <i>Tracer Code</i>	Codice Vite <i>Screw Code</i>	Prezzo <i>Price</i> [€URO]
PM53090	Mola Pr. V D.96 S=50	00	PM14804	PM14905	647
PM54090	Mola Pr. V D.96 S=50	2	PM14801	PM14905	647
PM35166	Mola Pr. V Rubber D.120 S=50	3	-	-	178
PM35167	Mola Pr. V Rubber D.120 S=50	4	-	-	178
PM35168	Mola Pr. V Rubber D.120 S=50	5	-	-	178
PM35169	Mola Pr. V Rubber D.120 S=50	6	-	-	178
COSTO SET COMPLETO - <i>COMPLETE SET PRICE</i>					2006

PM57090	Mola Pr. V D.96 S=50	00	PM14801	PM14905	647
Mola per profilatura unica in macchina (finitura manuale)					
<i>One Step Profiling Wheel (Finishing by Hand)</i>					

COMARTEX

☎ 01 45 76 53 03

☎ 01 45 76 76 82

mail : comartex@comartex.fr

site : www.comartex.com



De la qualité, des prix et du choix...

La preuve en vidéo sur le

www.COMARTEX.com

MOLA PROFILO **V60** MACCHINE MANUALI COMPLETA DI TASTATORE E VITE M8

*PROFILE **V60** WHEEL FOR HAND HELD MACHINE WITH TRACER AND SCREW M8*

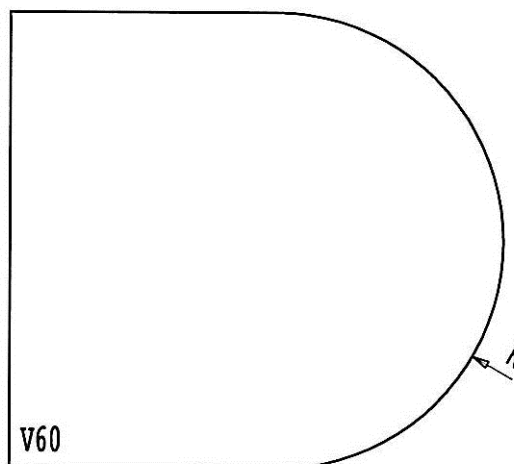

R=30

Codice ADI <i>ADI Code</i>	Descrizione <i>Description</i>	Posizione <i>Position</i>	Codice Tastatore <i>Tracer Code</i>	Codice Vite <i>Screw Code</i>	Prezzo <i>Price</i> [€URO]
PM53091	Mola Pr. V D.104 S=60	00	PM14804	PM14906	815
PM54091	Mola Pr. V D.104 S=60	2	PM14801	PM14906	815
PM35034	Mola Pr. V Rubber D.130 S=60	3	-	-	211
PM35035	Mola Pr. V Rubber D.130 S=60	4	-	-	211
PM35036	Mola Pr. V Rubber D.130 S=60	5	-	-	211
PM35037	Mola Pr. V Rubber D.130 S=60	6	-	-	211
COSTO SET COMPLETO - <i>COMPLETE SET PRICE</i>					2474

PM57091	Mola Pr. V D.104 S=60	00	PM14801	PM14906	815
Mola per profilatura unica in macchina (finitura manuale)					
<i>One Step Profiling Wheel (Finishing by Hand)</i>					

COMARTEX

☎ 01 45 76 53 03

☎ 01 45 76 76 82

mail : comartex@comartex.fr

site : www.comartex.com



De la qualité, des prix et du choix...

La preuve en vidéo sur le

www.COMARTEX.com

MOLA PROFILO **V+B30** MACCHINE MANUALI COMPLETA DI TASTATORE E VITE M8

*PROFILE **V+B30** WHEEL FOR HAND HELD MACHINE WITH TRACER AND SCREW M8*

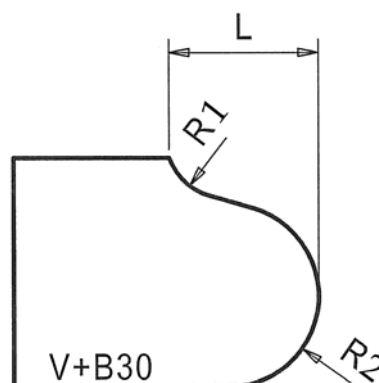

$$R1=8 \quad R2=12 \quad L=20$$

Codice ADI <i>ADI Code</i>	Descrizione <i>Description</i>	Posizione <i>Position</i>	Codice Tastatore <i>Tracer Code</i>	Codice Vite <i>Screw Code</i>	Prezzo <i>Price</i> [€URO]
PM53119	Mola Pr. V+B D.80 S=30	00	PM14804	PM14903	590
PM57119	Mola Pr. V+B D.80 S=30	2	PM14801	PM14903	590
PM35186	Mola Pr. V+B Rubber D.100 S=30	3	-	-	147
PM35187	Mola Pr. V+B Rubber D.100 S=30	4	-	-	147
PM35188	Mola Pr. V+B Rubber D.100 S=30	5	-	-	147
PM35189	Mola Pr. V+B Rubber D.100 S=30	6	-	-	147
COSTO SET COMPLETO - <i>COMPLETE SET PRICE</i>					1768

PM57119	Mola Pr. V+B D.80 S=30	00	PM14801	PM14903	590
Mola per profilatura unica in macchina (finitura manuale) <i>One Step Profiling Wheel (Finishing by Hand)</i>					

COMARTEX

☎ 01 45 76 53 03

☎ 01 45 76 76 82

mail : comartex@comartex.fr

site : www.comartex.com



De la qualité, des prix et du choix...

La preuve en vidéo sur le

www.COMARTEX.com

**MOLA PROFILO V+B40 MACCHINE MANUALI
COMPLETA DI TASTATORE E VITE M8**
**PROFILE V+B40 WHEEL FOR HAND HELD MACHINE
WITH TRACER AND SCREW M8**

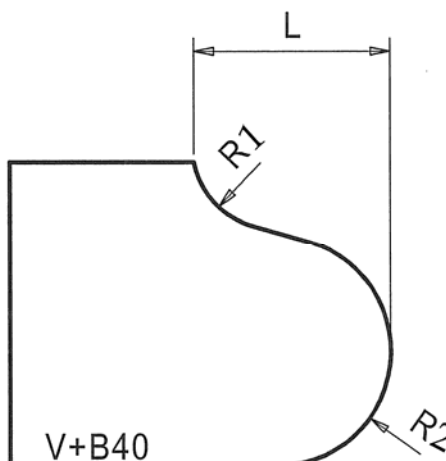

R1=11 R2=15 L=26

Codice ADI ADI Code	Descrizione Description	Posizione Position	Codice Tastatore Tracer Code	Codice Vite Screw Code	Prezzo Price [€URO]
PM53120	Mola Pr. V+B D.92 S=40	00	PM14804	PM14904	618
PM54120	Mola Pr. V+B D.92 S=40	2	PM14801	PM14904	618
PM35126	Mola Pr. V+B Rubber D.110 S=40	3	-	-	161
PM35127	Mola Pr. V+B Rubber D.110 S=40	4	-	-	161
PM35128	Mola Pr. V+B Rubber D.110 S=40	5	-	-	161
PM35129	Mola Pr. V+B Rubber D.110 S=40	6	-	-	161
COSTO SET COMPLETO - COMPLETE SET PRICE					1880

PM57120	Mola Pr. V+B D.92 S=40	00	PM14801	PM14904	618
Mola per profilatura unica in macchina (finitura manuale) One Step Profiling Wheel (Finishing by Hand)					

COMARTEX

☎ 01 45 76 53 03

☎ 01 45 76 76 82

mail : comartex@comartex.fr

site : www.comartex.com



De la qualité, des prix et du choix...

La preuve en vidéo sur le

www.COMARTEX.com

**MOLA PROFILO Z20 MACCHINE MANUALI COMPLETA DI
TASTATORE E VITE M8**

**PROFILE Z20 WHEEL FOR HAND HELD MACHINE
WITH TRACER AND SCREW M8**



1A1(Z)20

L=20

Codice ADI <i>ADI Code</i>	Descrizione <i>Description</i>	Posizione <i>Position</i>	Codice Tastatore <i>Tracer</i> <i>Code</i>	Codice Vite <i>Screw</i> <i>Code</i>	Prezzo <i>Price</i> [€URO]
PM53902	1A1 D. 40X20X4	1	PM14801	PM14962	325
PM54902	1A1 D. 40X20X4	2	PM14801	PM14962	325
PM35220	1A1 LUC D. 40X25	3	-	-	100
PM35221	1A1 LUC D. 40X25	4	-	-	100
PM35222	1A1 LUC D. 40X25	5	-	-	100
PM35223	1A1 LUC D. 40X25	6	-	-	100
COSTO SET COMPLETO - COMPLETE SET PRICE					1050

COMARTEX

☎ 01 45 76 53 03

☎ 01 45 76 76 82

mail : comartex@comartex.fr

site : www.comartex.com



De la qualité, des prix et du choix...

La preuve en vidéo sur le

www.COMARTEX.com

**MOLA PROFILO Z30 MACCHINE MANUALI COMPLETA DI
TASTATORE E VITE M8**

**PROFILE Z30 WHEEL FOR HAND HELD MACHINE
WITH TRACER AND SCREW M8**

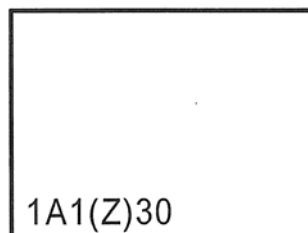

L=30

Codice ADI <i>ADI Code</i>	Descrizione <i>Description</i>	Posizione <i>Position</i>	Codice Tastatore <i>Tracer</i> <i>Code</i>	Codice Vite <i>Screw</i> <i>Code</i>	Prezzo <i>Price</i> [€URO]
PM53903	1A1 D. 40X30X4	1	PM14801	PM14903	348
PM54903	1A1 D. 40X30X4	2	PM14801	PM14903	348
PM35199	1A1 LUC D. 40X35	3	-	-	112
PM35200	1A1 LUC D. 40X35	4	-	-	112
PM35201	1A1 LUC D. 40X35	5	-	-	112
PM35202	1A1 LUC D. 40X35	6	-	-	112
COSTO SET COMPLETO - COMPLETE SET PRICE					1144



**MOLA PROFILO Z40 MACCHINE MANUALI COMPLETA DI
TASTATORE E VITE M8**

**PROFILE Z40 WHEEL FOR HAND HELD MACHINE
WITH TRACER AND SCREW M8**

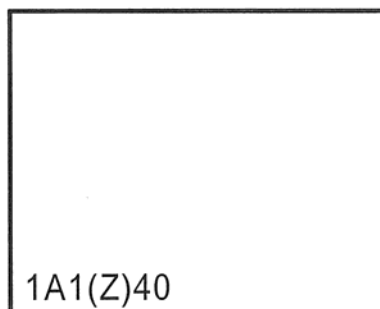

L=40

Codice ADI <i>ADI Code</i>	Descrizione <i>Description</i>	Posizione <i>Position</i>	Codice Tastatore <i>Tracer</i> <i>Code</i>	Codice Vite <i>Screw</i> <i>Code</i>	Prezzo <i>Price</i> [€URO]
PM53904	1A1 D. 40X40X4	1	PM14801	PM14905	375
PM54904	1A1 D. 40X40X4	2	PM14801	PM14905	375
PM35224	1A1 LUC D. 40X45	3	-	-	124
PM35225	1A1 LUC D. 40X45	4	-	-	124
PM35226	1A1 LUC D. 40X45	5	-	-	124
PM35227	1A1 LUC D. 40X45	6	-	-	124
COSTO SET COMPLETO - COMPLETE SET PRICE					1246

COMARTEX

☎ 01 45 76 53 03

☎ 01 45 76 76 82

mail : comartex@comartex.fr

site : www.comartex.com



De la qualité, des prix et du choix...

La preuve en vidéo sur le

www.COMARTEX.com

**MOLA PROFILO ZR20 MACCHINE MANUALI COMPLETA DI
TASTATORE E VITE M8**

**PROFILE ZR20 WHEEL FOR HAND HELD MACHINE
WITH TRACER AND SCREW M8**



R=5

Codice ADI <i>ADI Code</i>	Descrizione <i>Description</i>	Posizione <i>Position</i>	Codice Tastatore <i>Tracer Code</i>	Codice Vite <i>Screw Code</i>	Prezzo <i>Price</i> [€URO]
PM53151	MOLA PR. ZR D. 58 S=20	00	PM14809	PM14902	312
PM54151	MOLA PR. ZR D. 58 S=20	2	PM14805	PM14902	312
PM35228	MOLA PR. ZR LUC D. 65 S=20	3	-	-	127
PM35229	MOLA PR. ZR LUC D. 65 S=20	4	-	-	127
PM35230	MOLA PR. ZR LUC D. 65 S=20	5	-	-	127
PM35231	MOLA PR. ZR LUC D. 65 S=20	6	-	-	127
COSTO SET COMPLETO - <i>COMPLETE SET PRICE</i>					1132

PM57151	MOLA PR. ZR D. 58 S=20	00	PM14805	PM14902	312
Mola per profilatura unica in macchina (finitura manuale) <i>One Step Profiling Wheel (Finishing by Hand)</i>					

COMARTEX

☎ 01 45 76 53 03

☎ 01 45 76 76 82

mail : comartex@comartex.fr

site : www.comartex.com



De la qualité, des prix et du choix...

La preuve en vidéo sur le

www.COMARTEX.com

MOLA PROFILO ZR30 MACCHINE MANUALI COMPLETA DI TASTATORE E VITE M8

PROFILE ZR30 WHEEL FOR HAND HELD MACHINE WITH TRACER AND SCREW M8

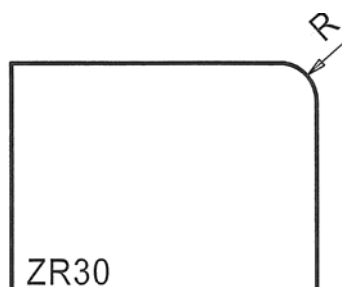

R=5

Codice ADI <i>ADI Code</i>	Descrizione <i>Description</i>	Posizione <i>Position</i>	Codice Tastatore <i>Tracer Code</i>	Codice Vite <i>Screw Code</i>	Prezzo <i>Price</i> [€URO]
PM53152	MOLA PR. ZR D. 58 S=30	00	PM14809	PM14905	366
PM54152	MOLA PR. ZR D. 58 S=30	2	PM14805	PM14905	366
PM35232	MOLA PR. ZR LUC D. 65 S=30	3	-	-	135
PM35233	MOLA PR. ZR LUC D. 65 S=30	4	-	-	135
PM35234	MOLA PR. ZR LUC D. 65 S=30	5	-	-	135
PM35235	MOLA PR. ZR LUC D. 65 S=30	6	-	-	135
COSTO SET COMPLETO - <i>COMPLETE SET PRICE</i>					1272

PM57152	MOLA PR. ZR D. 58 S=30	00	PM14805	PM14905	366
Mola per profilatura unica in macchina (finitura manuale) <i>One Step Profiling Wheel (Finishing by Hand)</i>					

COMARTEX

☎ 01 45 76 53 03

☎ 01 45 76 76 82

mail : comartex@comartex.fr

site : www.comartex.com



De la qualité, des prix et du choix...

La preuve en vidéo sur le

www.COMARTEX.com

MOLA PROFILO ZR40 MACCHINE MANUALI COMPLETA DI TASTATORE E VITE M8

PROFILE ZR40 WHEEL FOR HAND HELD MACHINE WITH TRACER AND SCREW M8

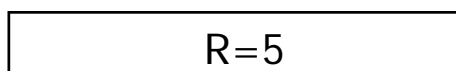
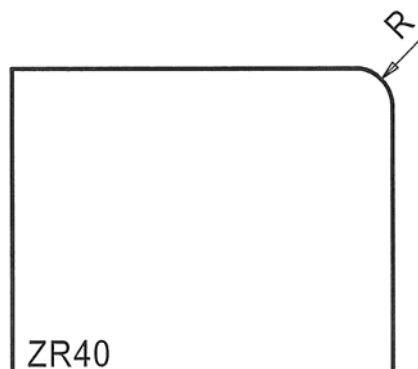

Codice ADI <i>ADI Code</i>	Descrizione <i>Description</i>	Posizione <i>Position</i>	Codice Tastatore <i>Tracer Code</i>	Codice Vite <i>Screw Code</i>	Prezzo <i>Price</i> [€URO]
PM53153	MOLA PR. ZR D. 58 S=40	00	PM14809	PM14906	366
PM54153	MOLA PR. ZR D. 58 S=40	2	PM14805	PM14906	366
PM35236	MOLA PR. ZR LUC D. 65 S=40	3	-	-	148
PM35237	MOLA PR. ZR LUC D. 65 S=40	4	-	-	148
PM35238	MOLA PR. ZR LUC D. 65 S=40	5	-	-	148
PM35239	MOLA PR. ZR LUC D. 65 S=40	6	-	-	148
COSTO SET COMPLETO - <i>COMPLETE SET PRICE</i>					1324

PM57153	MOLA PR. ZR D. 58 S=40	00	PM14805	PM14906	366
Mola per profilatura unica in macchina (finitura manuale) <i>One Step Profiling Wheel (Finishing by Hand)</i>					

COMARTEX

☎ 01 45 76 53 03

☎ 01 45 76 76 82

mail : comartex@comartex.fr

site : www.comartex.com



De la qualité, des prix et du choix...

La preuve en vidéo sur le

www.COMARTEX.com

MOLA PROFILO **ZS20** MACCHINE MANUALI COMPLETA DI TASTATORE E VITE M8

PROFILE **ZS20** WHEEL FOR HAND HELD MACHINE WITH TRACER AND SCREW M8

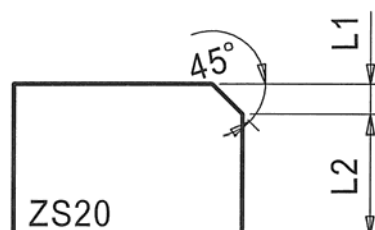

$$L1=4 \quad L2=16 \quad \alpha=45^\circ$$

Codice ADI <i>ADI Code</i>	Descrizione <i>Description</i>	Posizione <i>Position</i>	Codice Tastatore <i>Tracer Code</i>	Codice Vite <i>Screw Code</i>	Prezzo <i>Price</i> [€URO]
PM53154	MOLA PR. ZS D. 55 S=20	00	PM14809	PM14903	312
PM54154	MOLA PR. ZS D. 55 S=20	2	PM14805	PM14903	312
PM35240	MOLA PR. ZS LUC D. 80 S=20	3	-	-	127
PM35241	MOLA PR. ZS LUC D. 80 S=20	4	-	-	127
PM35242	MOLA PR. ZS LUC D. 80 S=20	5	-	-	127
PM35243	MOLA PR. ZS LUC D. 80 S=20	6	-	-	127
COSTO SET COMPLETO - <i>COMPLETE SET PRICE</i>					1132

PM57154	MOLA PR. ZS D. 55 S=20	00	PM14805	PM14903	312
---------	------------------------	----	---------	---------	-----

Mola per profilatura unica in macchina (finitura manuale)

One Step Profiling Wheel (Finishing by Hand)

COMARTEX

☎ 01 45 76 53 03

☎ 01 45 76 76 82

mail : comartex@comartex.fr

site : www.comartex.com



De la qualité, des prix et du choix...

La preuve en vidéo sur le

www.COMARTEX.com

MOLA PROFILO **ZS30** MACCHINE MANUALI COMPLETA DI TASTATORE E VITE M8

PROFILE **ZS30** WHEEL FOR HAND HELD MACHINE WITH TRACER AND SCREW M8

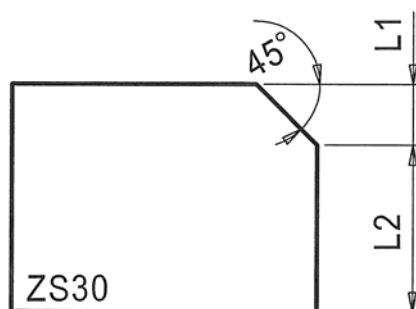

$$L1=8 \quad L2=22 \quad \alpha=45^\circ$$

Codice ADI <i>ADI Code</i>	Descrizione <i>Description</i>	Posizione <i>Position</i>	Codice Tastatore <i>Tracer Code</i>	Codice Vite <i>Screw Code</i>	Prezzo <i>Price</i> [€URO]
PM53155	MOLA PR. ZS D. 61 S=30	00	PM14809	PM14905	366
PM54155	MOLA PR. ZS D. 61 S=30	2	PM14805	PM14905	366
PM35244	MOLA PR. ZS LUC D. 80 S=30	3	-	-	135
PM35245	MOLA PR. ZS LUC D. 80 S=30	4	-	-	135
PM35246	MOLA PR. ZS LUC D. 80 S=30	5	-	-	135
PM35247	MOLA PR. ZS LUC D. 80 S=30	6	-	-	135
COSTO SET COMPLETO - <i>COMPLETE SET PRICE</i>					1272

PM57155	MOLA PR. ZS D. 61 S=30	00	PM14805	PM14905	366
Mola per profilatura unica in macchina (finitura manuale) <i>One Step Profiling Wheel (Finishing by Hand)</i>					

COMARTEX

☎ 01 45 76 53 03

☎ 01 45 76 76 82

mail : comartex@comartex.fr

site : www.comartex.com



De la qualité, des prix et du choix...

La preuve en vidéo sur le

www.COMARTEX.com

MOLA PROFILO **ZS40** MACCHINE MANUALI COMPLETA DI TASTATORE E VITE M8

PROFILE **ZS40** WHEEL FOR HAND HELD MACHINE WITH TRACER AND SCREW M8

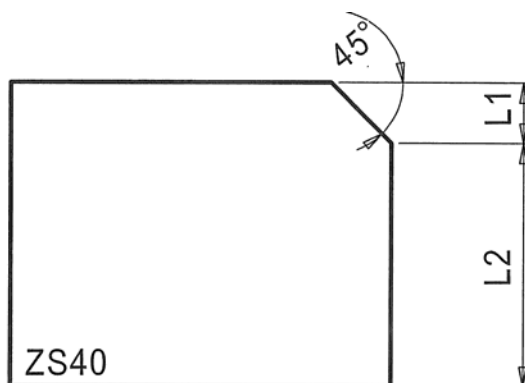

$$L1=8 \quad L2=32 \quad \alpha =45^\circ$$

Codice ADI <i>ADI Code</i>	Descrizione <i>Description</i>	Posizione <i>Position</i>	Codice Tastatore <i>Tracer Code</i>	Codice Vite <i>Screw Code</i>	Prezzo <i>Price</i> [€URO]
PM53156	MOLA PR. ZS D. 61 S=40	00	PM14809	PM14905	366
PM54156	MOLA PR. ZS D. 61 S=40	2	PM14805	PM14905	366
PM35248	MOLA PR. ZS LUC D. 80 S=40	3	-	-	148
PM35249	MOLA PR. ZS LUC D. 80 S=40	4	-	-	148
PM35250	MOLA PR. ZS LUC D. 80 S=40	5	-	-	148
PM35251	MOLA PR. ZS LUC D. 80 S=40	6	-	-	148
COSTO SET COMPLETO - <i>COMPLETE SET PRICE</i>					1324

PM57156	MOLA PR. ZS D. 61 S=40	00	PM14805	PM14905	366
Mola per profilatura unica in macchina (finitura manuale) <i>One Step Profiling Wheel (Finishing by Hand)</i>					

COMARTEX

☎ 01 45 76 53 03

☎ 01 45 76 76 82

mail : comartex@comartex.fr

site : www.comartex.com



De la qualité, des prix et du choix...

La preuve en vidéo sur le

www.COMARTEX.com

TASTATORE INTERNO - INTERNAL TRACER



Adi code	Description	Prezzo Price [€URO]
PM14801	TOUCHER D.40	34
PM14803	TOUCHER D.40,6	
PM14804	TOUCHER D.41	

TASTATORE ESTERNO - EXTERNAL TRACER



Adi code	Description	Prezzo Price [€URO]
PM14805	TOUCHER D.40	34
PM14807	TOUCHER D.40,6	
PM14809	TOUCHER D.41	

COMARTEX

☎ 01 45 76 53 03

☎ 01 45 76 76 82

mail : comartex@comartex.fr

site : www.comartex.com



De la qualité, des prix et du choix...

La preuve en vidéo sur le

www.COMARTEX.com

VITE CALIBRATA PER MOLE PER MACCHINE MANUALI (M8)
CALIBRATED SCREW FOR HAND HELD MACHINE (M8 THREAD)



Adi code	Description	Prezzo Price [€URO]
PM14902	VITE/SCREW M8X16	6
PM14903	VITE/SCREW M8X20	
PM14904	VITE/SCREW M8X25	
PM14905	VITE/SCREW M8X30	
PM14906	VITE/SCREW M8X40	

VITE CALIBRATA PER MOLE PER MACCHINE MANUALI MAGNUM - GHINES M10
CALIBRATED SCREW FOR MAGNUM - GHINES HAND HELD MACHINE (M10 THREAD)



Adi code	Description	Prezzo Price [€URO]
PM14963	VITE/SCREW M10X16	6
PM14964	VITE/SCREW M10X20	
PM14965	VITE/SCREW M10X25	
PM14966	VITE/SCREW M10X30	
PM14967	VITE/SCREW M10X40	



ADATTATORE PER MOLE MACCHINE MANUALI—M8 –M10
ADAPTOR FOR WHEELS OF HAND HELD MACHINES-M8-M10



Adi code	Description	Prezzo Price [€URO]
SL02357	ATTACCO A=1/2" GAS - ATT.= 22,2-M10	57
SL02328	ATTACCO A=1/2" GAS - ATT.= 22,2 - M8	57

COMARTEX

☎ 01 45 76 53 03

☎ 01 45 76 76 82

mail : comartex@comartex.fr

site : www.comartex.com



De la qualité, des prix et du choix...

La preuve en vidéo sur le

www.COMARTEX.com